

TOXAWAY STREET

SANITARY SEWER REHABILITATION

(PROJECT NO. 2019004)

MSD OF BUNCOMBE COUNTY

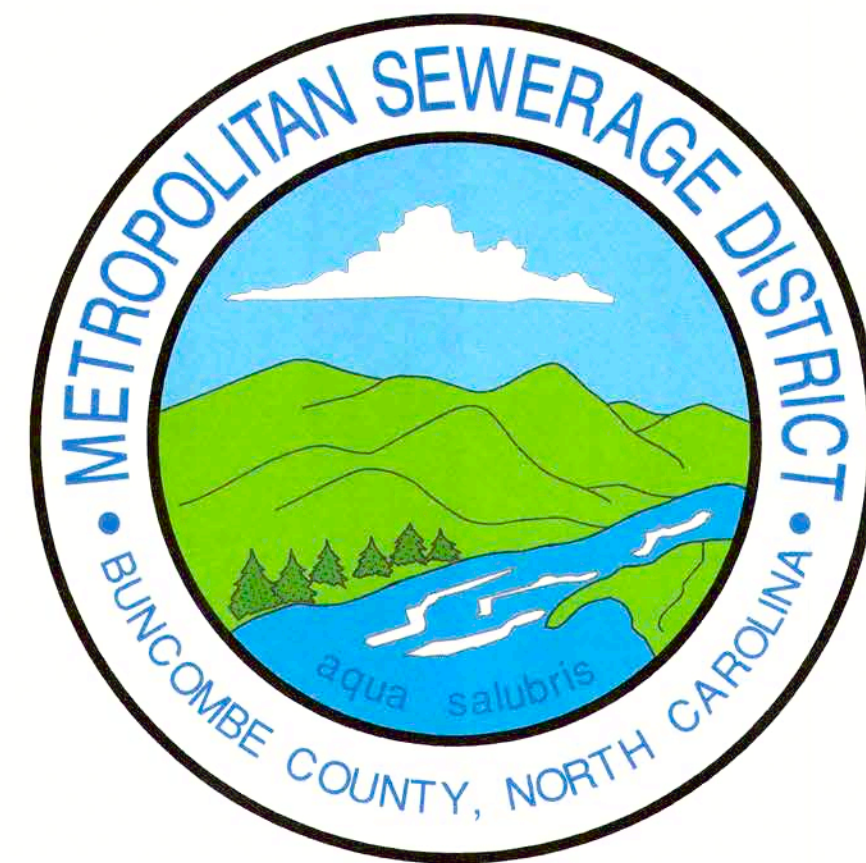

INDEX OF DRAWINGS	
SHEET NO.	DESCRIPTION
C-1	INDEX OF DRAWINGS AND VICINITY MAP
PL-1	SANITARY SEWER PLAN & PROFILE
D-1	SANITARY SEWER DETAILS



LEGEND			
◆ FFE	FINISHED FLOOR ELEVATION	1	PROPOSED ABANDON PLUG
●	EXISTING IRON PIN FOUND	1	PROPOSED MANHOLE NUMBER
▲	SIGN	1	PROPOSED ABANDON SEWER MANHOLE
▲ GV	GAS VALVE	1	PROPOSED CLEANOUT
●	GAS METER	1	SANITARY SEWER MANHOLE
■ CI	CURB INLET	1	EXISTING CLEANOUT
○	STORM MANHOLE	● EXCO	WATER VALVE
■ CB	CATCH BASIN	● WV	FIRE HYDRANT
		● PH	WATER METER
		● WM	UTILITY POLE
		●	GUY WIRE
		●	LIGHT POLE

- GENERAL NOTES:**
- LENGTHS SHOWN ARE NOT ACTUAL PIPE LENGTHS BUT ARE DISTANCES STATION TO STATION. SLOPES SHOWN ON THE PROFILE ARE CALCULATED USING LENGTHS FROM INSIDE EDGES OF MANHOLE.
 - ALL WORK ON THIS PROJECT SHALL COMPLY WITH THE CURRENT STANDARD DETAILS AND SPECIFICATIONS OF THE METROPOLITAN SEWERAGE DISTRICT OF BUNCOMBE COUNTY. SPECIAL CONDITIONS AND SPECIAL PROVISIONS MAY APPLY TO THIS PROJECT - SEE SPECIFICATIONS.
 - ALL WORK SHALL COMPLY WITH FEDERAL, STATE, AND LOCAL LAWS AND REGULATIONS, AS MAY BE APPLICABLE TO THIS PROJECT AND THE WORK DONE HEREUNDER.
 - WHERE FEDERAL, STATE, OR LOCAL LAWS REQUIRE THAT A PERMIT BE ISSUED AND OBTAINED FOR WORK DONE UNDER THIS PROJECT, ALL WORK PERFORMED BY THE CONTRACTOR SHALL BE PERFORMED IN STRICT COMPLIANCE WITH THE TERMS AND CONDITIONS SET FORTH IN THE PERMIT.
 - ANY MODIFICATIONS TO THESE CONSTRUCTION PLANS OR SPECIFICATIONS SHALL BE APPROVED BY THE MSD PROJECT ENGINEER.
 - THE CONTRACTOR SHALL VERIFY THE LOCATION OF ALL UNDERGROUND UTILITIES PRIOR TO THE START OF CONSTRUCTION.
 - THE CONTRACTOR SHALL TAKE ALL NECESSARY STEPS TO KEEP THE SEWER AND ALL OTHER UTILITIES IN SERVICE AT ALL TIMES DURING CONSTRUCTION. THE CONTRACTOR SHALL ASSUME ALL RESPONSIBILITY FOR REPAIRS OF ANY KIND FOR DAMAGES RESULTING FROM THE CONTRACTOR'S CONSTRUCTION ACTIVITIES.
 - THE CONTRACTOR SHALL LOCATE ALL SERVICES CURRENTLY SERVED BY THE EXISTING SEWER AND RECONNECT TO THE NEW SEWER, INSTALLING A CLEANOUT ASSEMBLY AS REQUIRED (SEE DETAIL).
 - THE CONTRACTOR SHALL RESTORE ALL STREETS, PROPERTIES, AND IMPROVEMENTS TO AS GOOD OR BETTER CONDITION THAN EXISTED PRIOR TO CONSTRUCTION.
 - PROPERTY LINES SHOWN ON PLANS ARE APPROXIMATE ONLY. PROPERTY MONUMENTS DISTURBED DURING CONSTRUCTION SHALL BE RESET BY A LICENSED NC PROFESSIONAL LAND SURVEYOR.
 - DESIGN BASED ON SURVEY INFORMATION PROVIDED BY NC SURVEY PC., 828-252-1530.

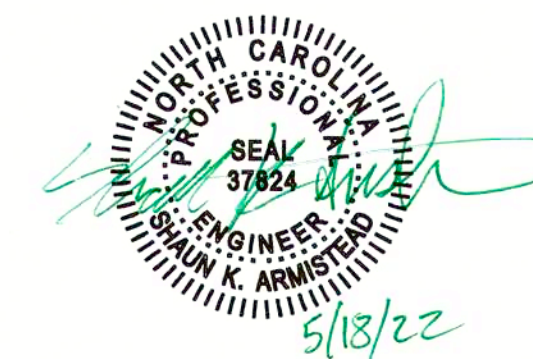
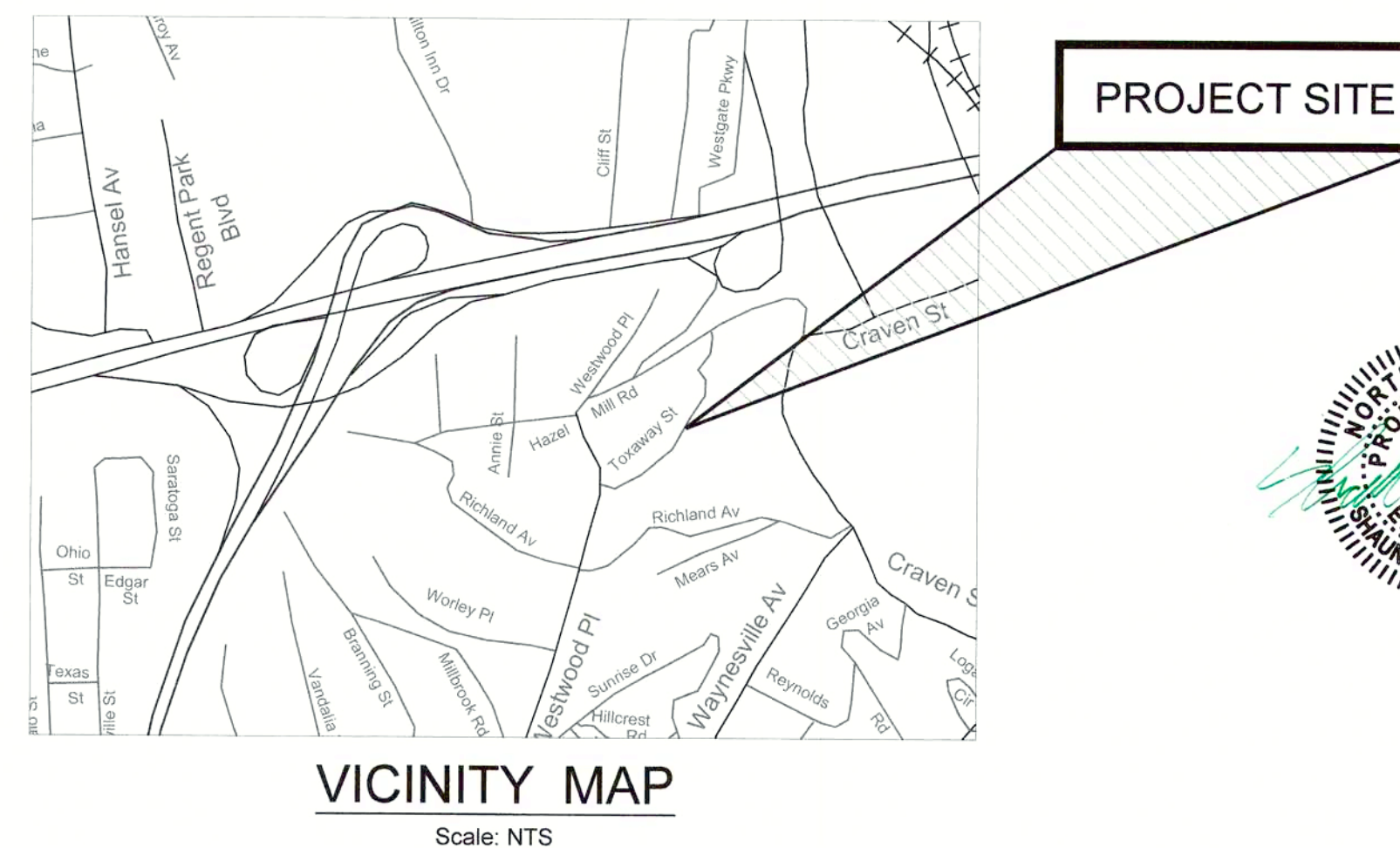

---	PROPOSED SANITARY SEWER LINE
---	EXISTING SANITARY SEWER LINE
---	EXISTING PERMANENT EASEMENT
---	PROPOSED PERMANENT EASEMENT
---	PROPOSED TEMPORARY EASEMENT
---	PROPOSED SILT FENCE LINE
---	PROPOSED ASPHALT SURFACE REPAIR
---	EXISTING PROPERTY LINE
---	EXISTING WATER LINE
---	EXISTING GAS LINE
---	EXISTING OVER HEAD UTILITY LINE
---	EXISTING UNDERGROUND UTILITY
---	EXISTING STORM DRAINAGE PIPE
---	EXISTING FENCE LINE
---	EXISTING TREE LINE
---	EXISTING GRAVEL AREA (RIP-RAP)
---	EXISTING ASPHALT ROADWAY
---	EXISTING BUILDING
---	EXISTING MAJOR CONTOUR
---	EXISTING MINOR CONTOUR

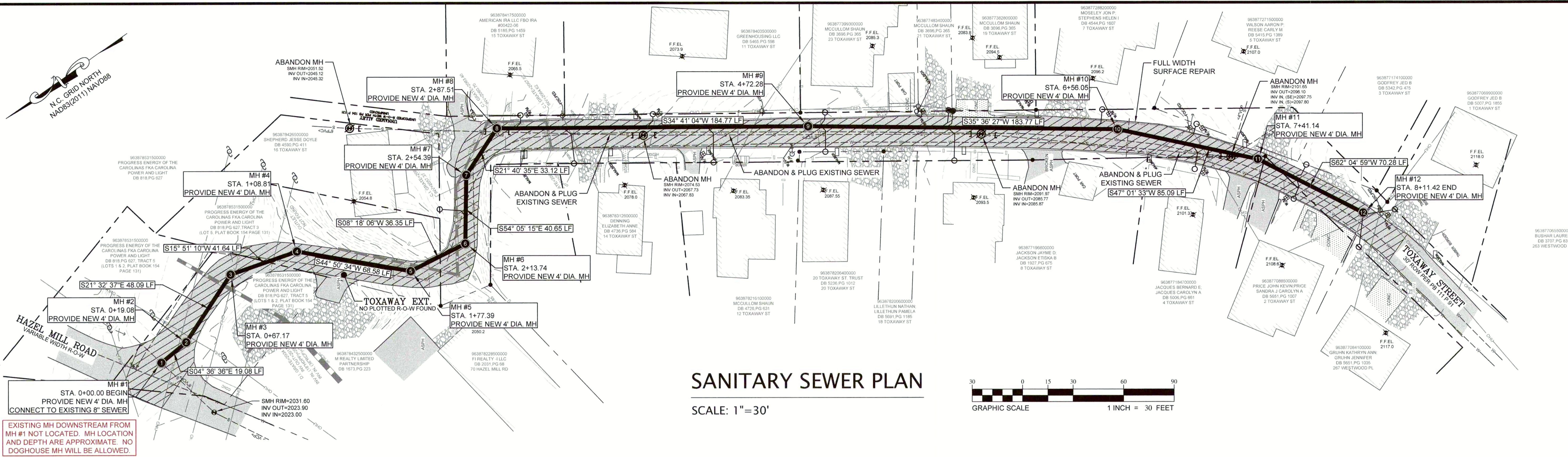
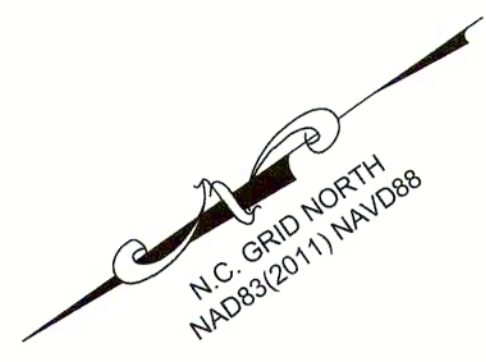

SANITARY SEWER PLAN
SCALE: 1" = 30'

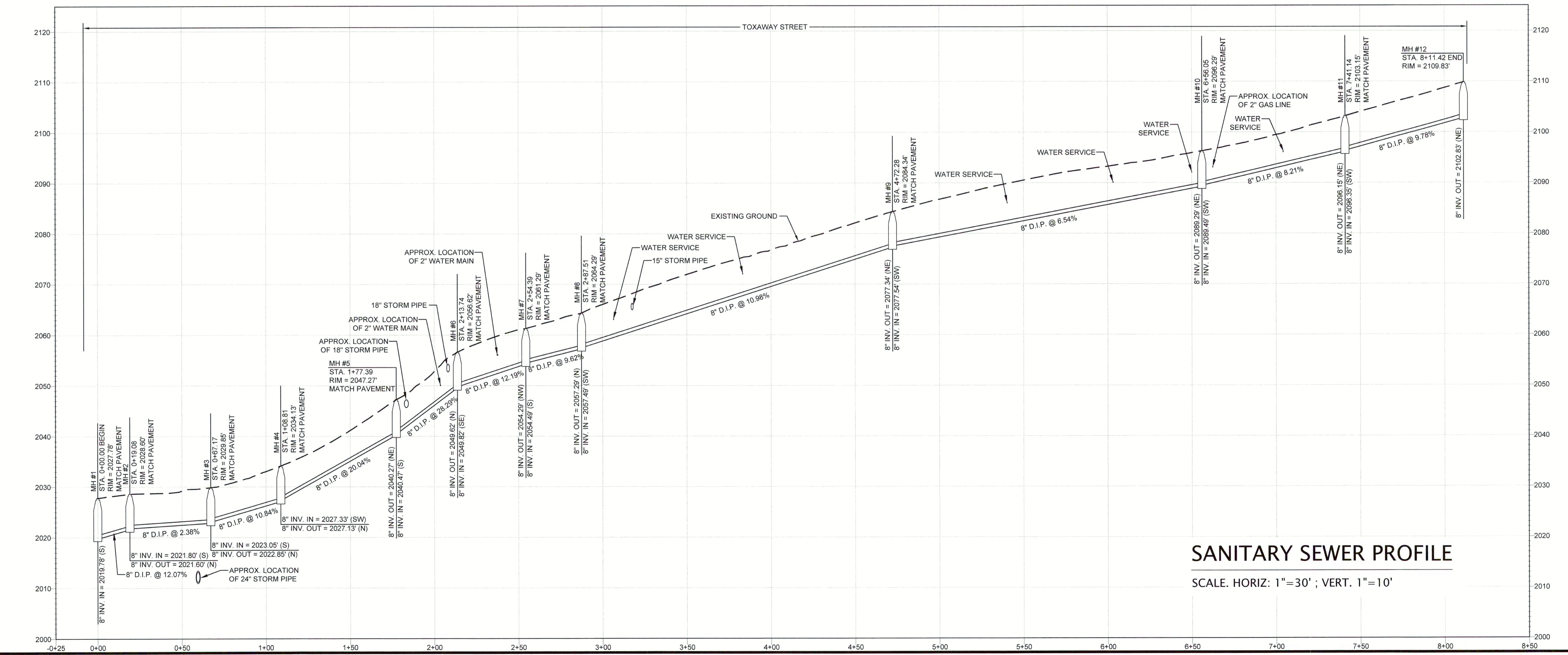
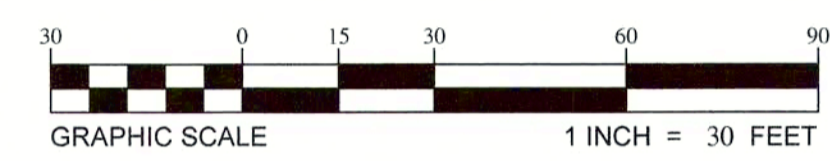

SANITARY SEWER PROFILE
SCALE: HORIZ: 1" = 30' ; VERT: 1" = 10'

Metropolitan Sewerage District
of Buncombe County
TOXAWAY STREET
Sanitary Sewer Plan & Profile
PL-1

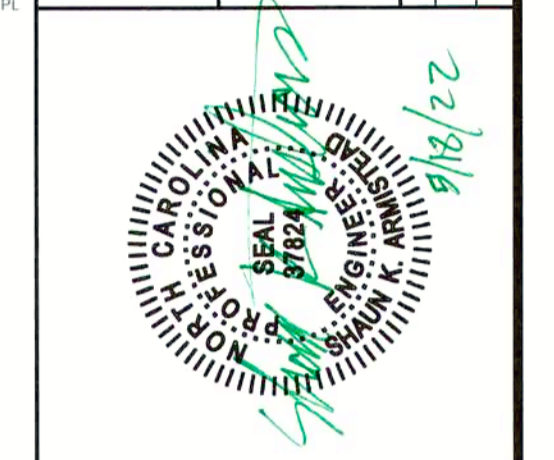

DATE	DESCRIPTION	REVISIONS

MSD

Metropolitan Sewerage District of Buncombe County

Engineering Division

P:\COLLECTIONS\SYSTEMS\DWG\GENERAL\DWG\TOXAWAY\TOXAWAY_SSP.dwg, 5/18/2022 8:47 AM, JDL

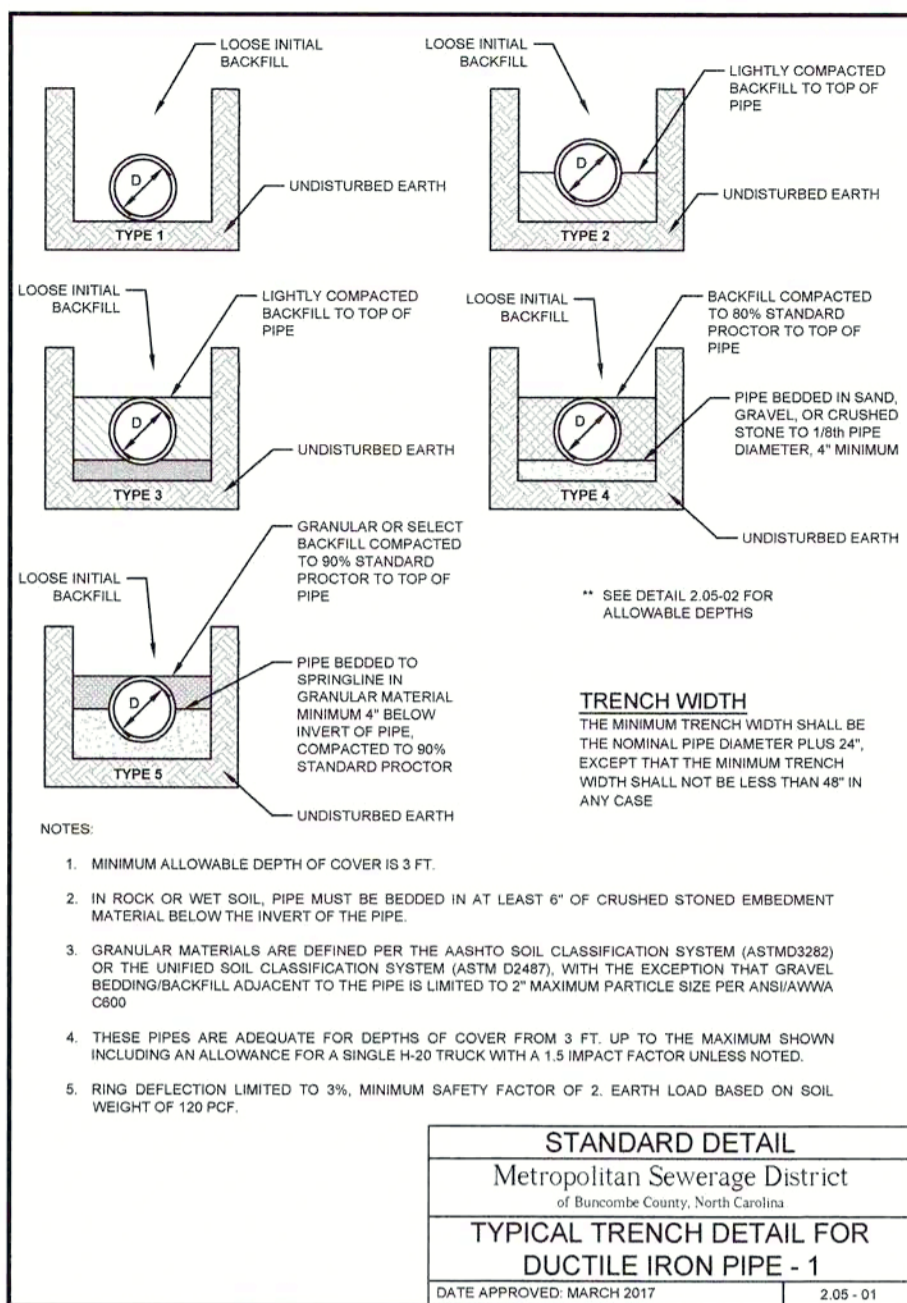
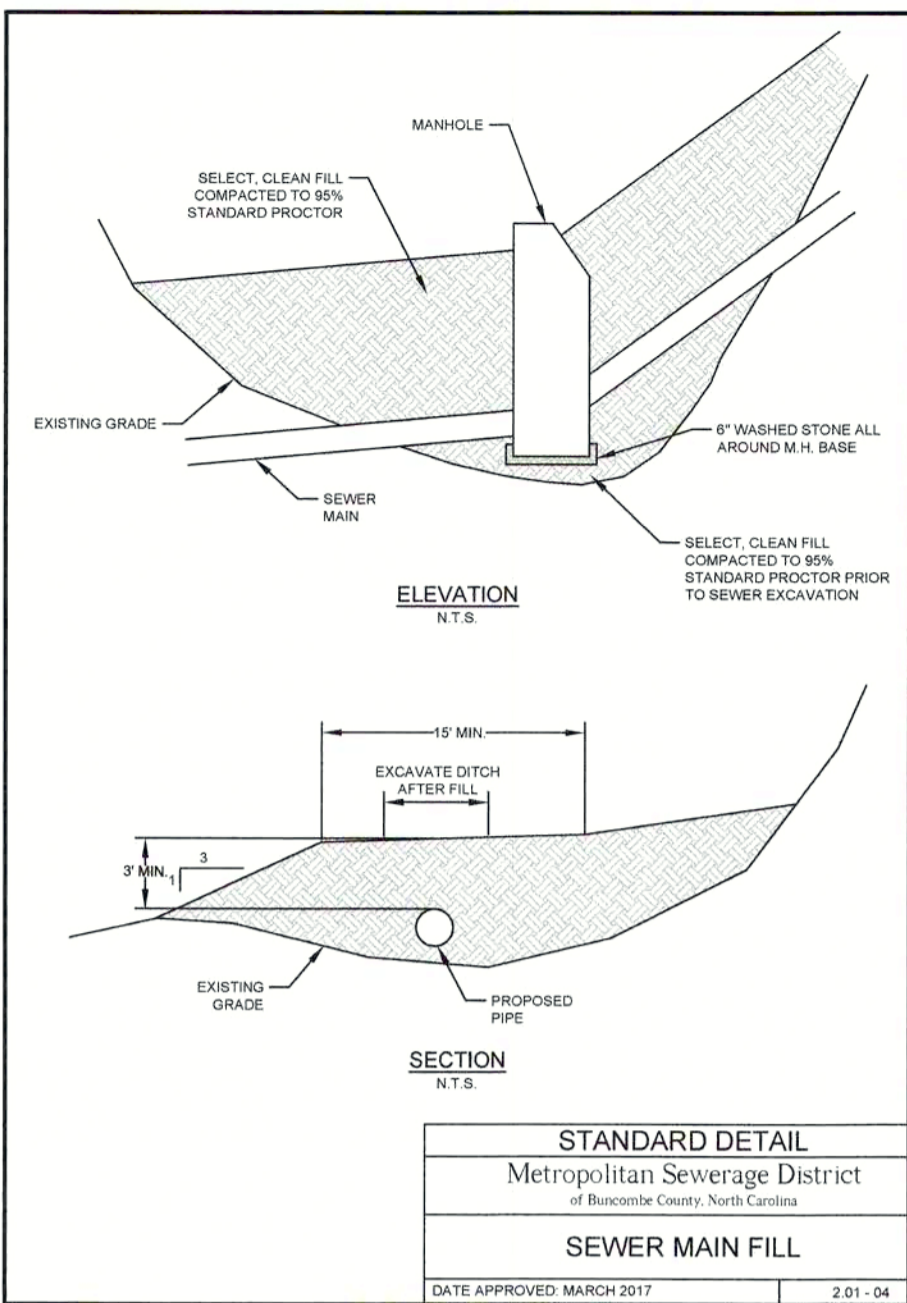
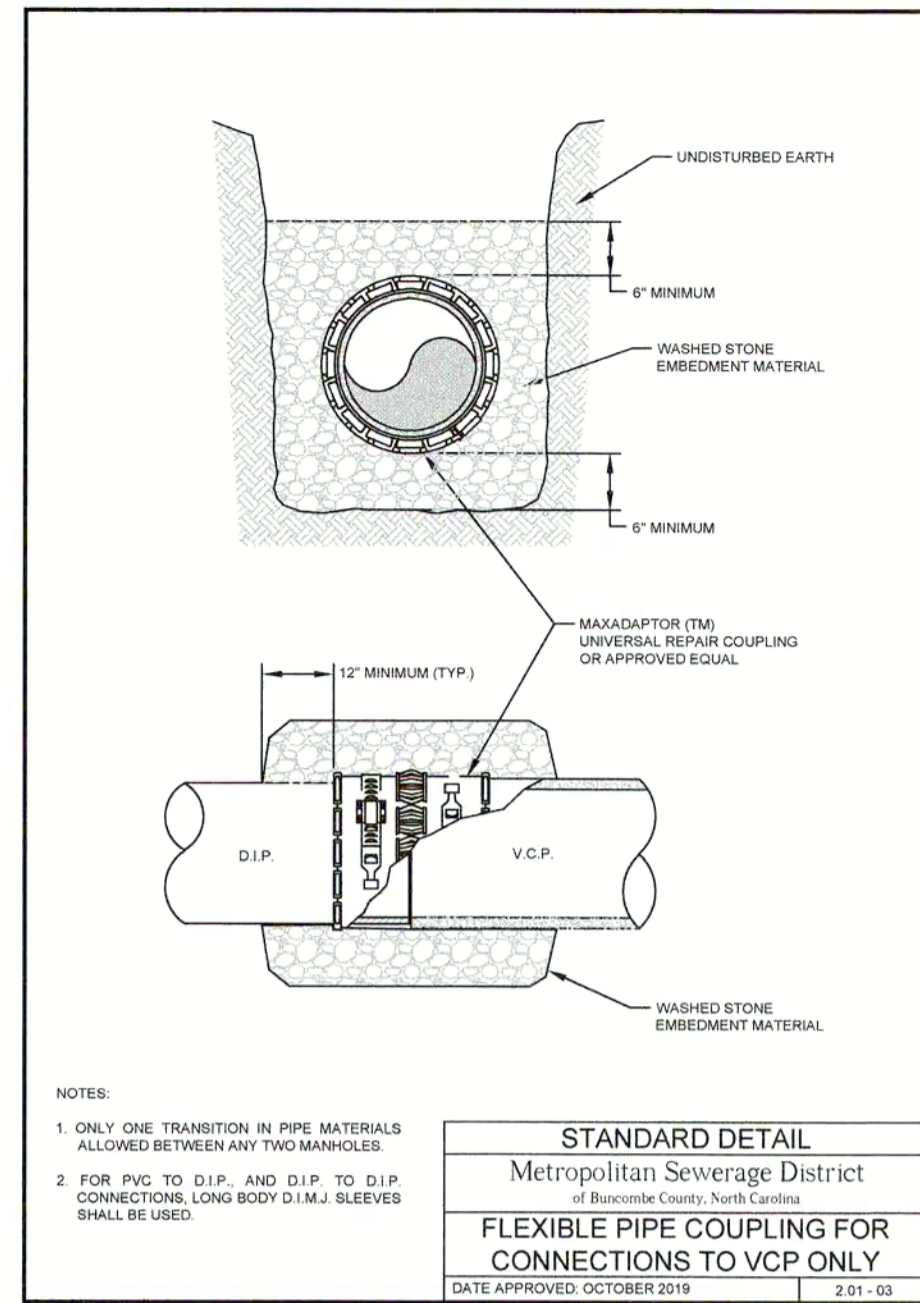
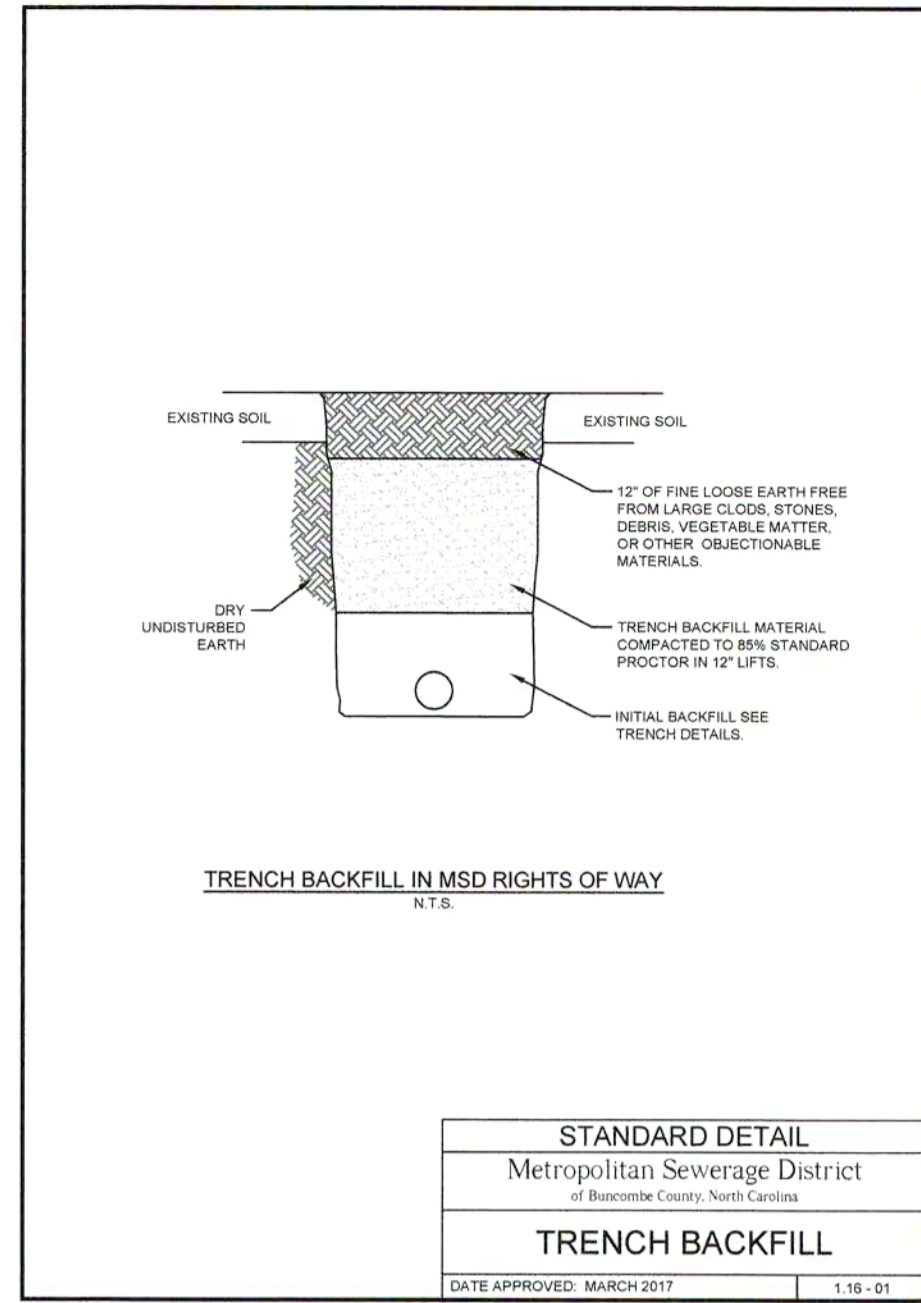

TYPICAL TRENCH DETAIL FOR DUCTILE IRON PIPE - 2
N.T.S.

Pipe Size	Class	Type 1	Type 2	Type 3	Type 4	Type 5
4	300	33	61	69	65	100
6	300	26	31	47	49	69
8	300	19	20	29	34	50
10	300	11	15	18	28	41
12	300	10	15	19	28	44
14	300	-	13	17	26	42
16	300	-	14	19	27	44
18	300	-	11	15	25	39
18	300	-	13	17	26	44
18	300	-	10	14	22	31
18	300	-	13	17	26	38
18	300	-	15	19	28	41
20	300	-	13	17	26	35
20	300	-	15	19	28	39
24	300	-	8	12	17	23
24	300	-	11	15	20	29
24	300	-	13	17	24	32
24	300	-	15	19	26	37
24	300	-	17	21	29	34
24	300	-	11	15	19	27
24	300	-	12	16	21	29
24	300	-	15	19	25	33
24	300	-	17	21	27	35
24	300	-	15	19	23	32
24	300	-	8	12	15	23
24	300	-	10	14	18	26
24	300	-	12	16	20	28
24	300	-	15	19	24	32
24	300	-	17	21	26	34
24	300	-	15	18	22	30
24	300	-	8	13	18	25
24	300	-	10	13	18	24
24	300	-	15	18	22	30
24	300	-	17	21	27	35
24	300	-	15	18	23	32
24	300	-	8	11	14	22
24	300	-	10	13	18	24
24	300	-	13	16	19	26
24	300	-	15	18	21	28
24	300	-	17	20	23	31
24	300	-	8	11	14	21
24	300	-	10	13	16	24
24	300	-	12	15	18	26
24	300	-	15	18	21	29
24	300	-	17	20	23	31

DATE APPROVED: MARCH 2017 2.05-02

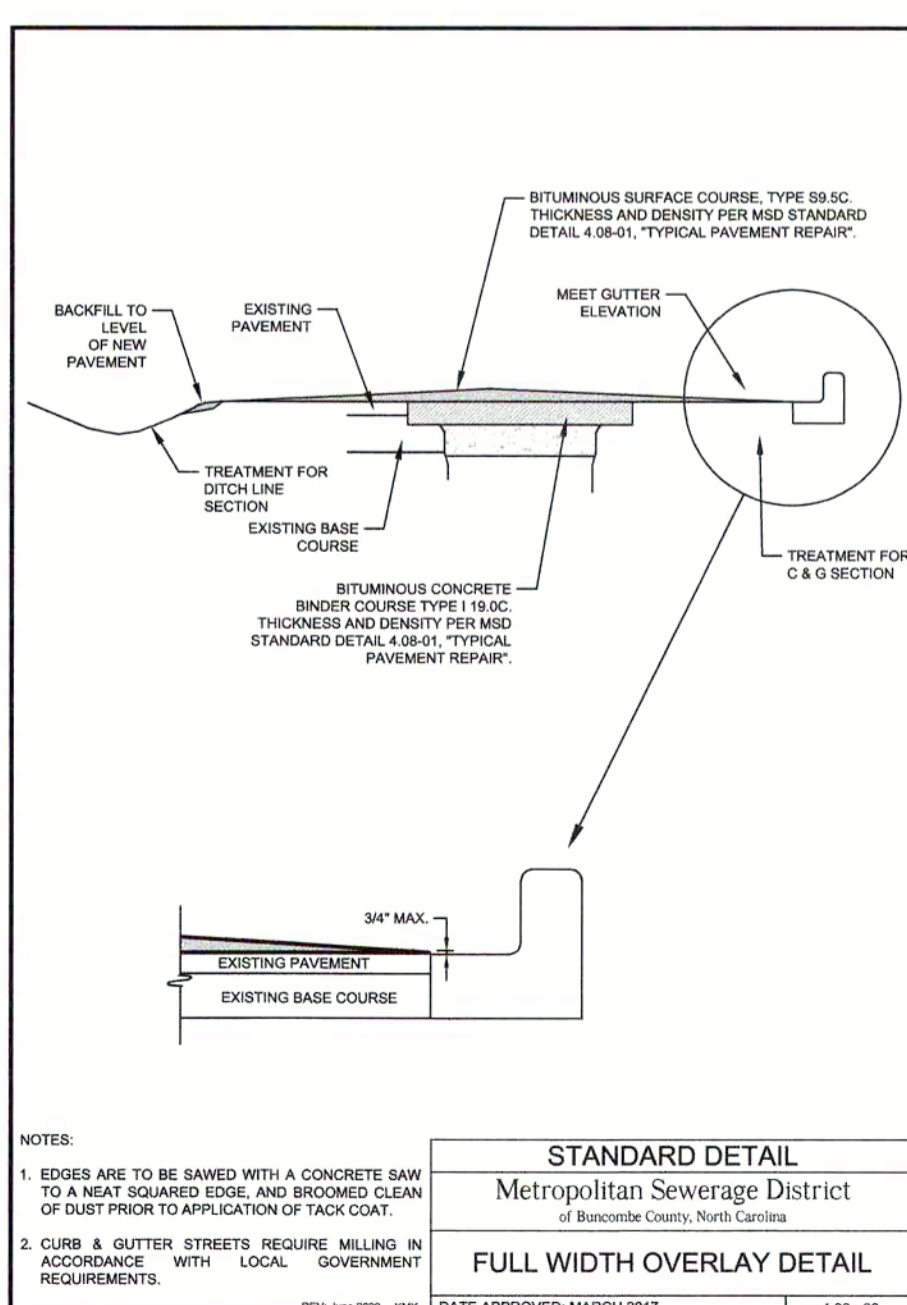
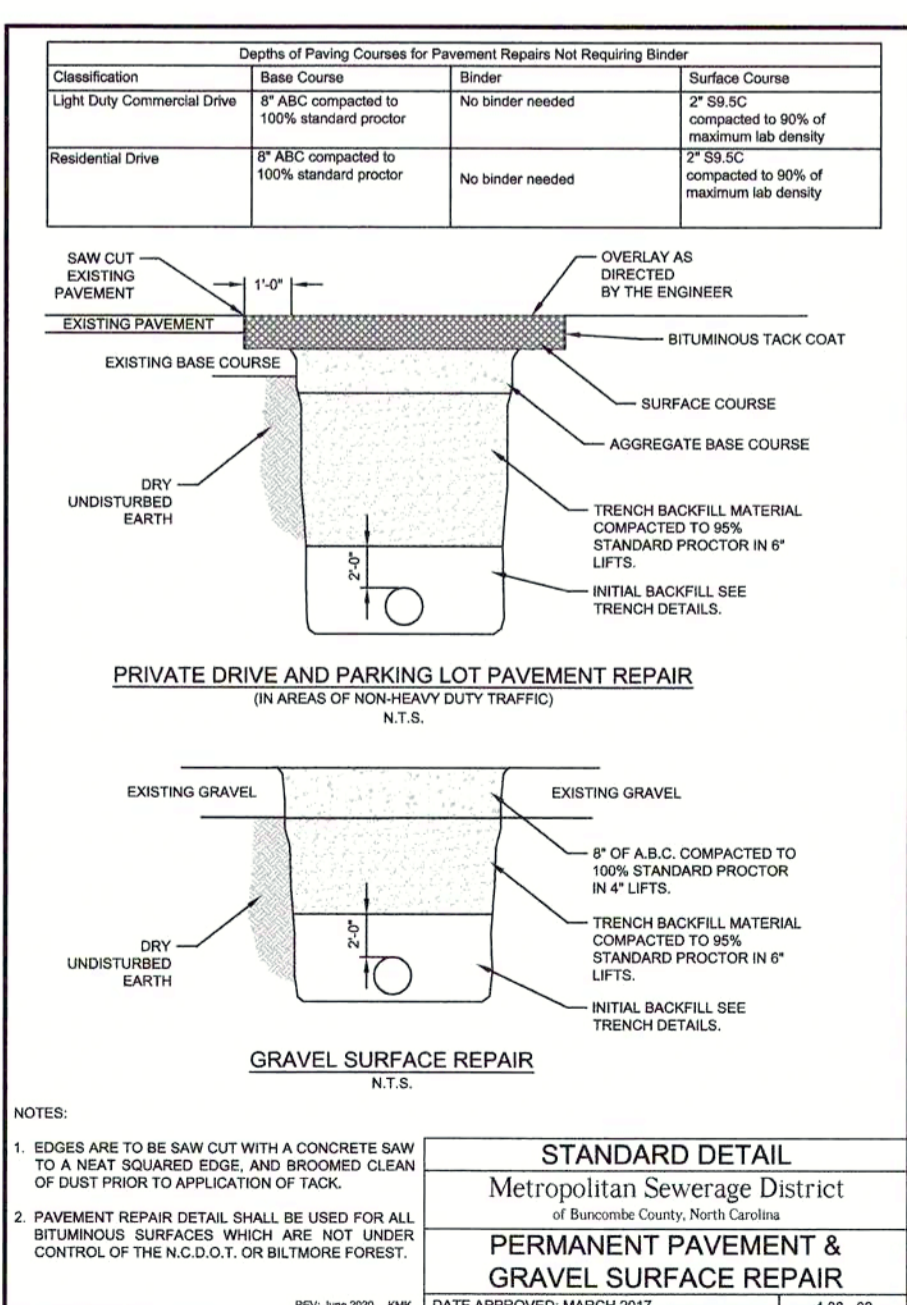
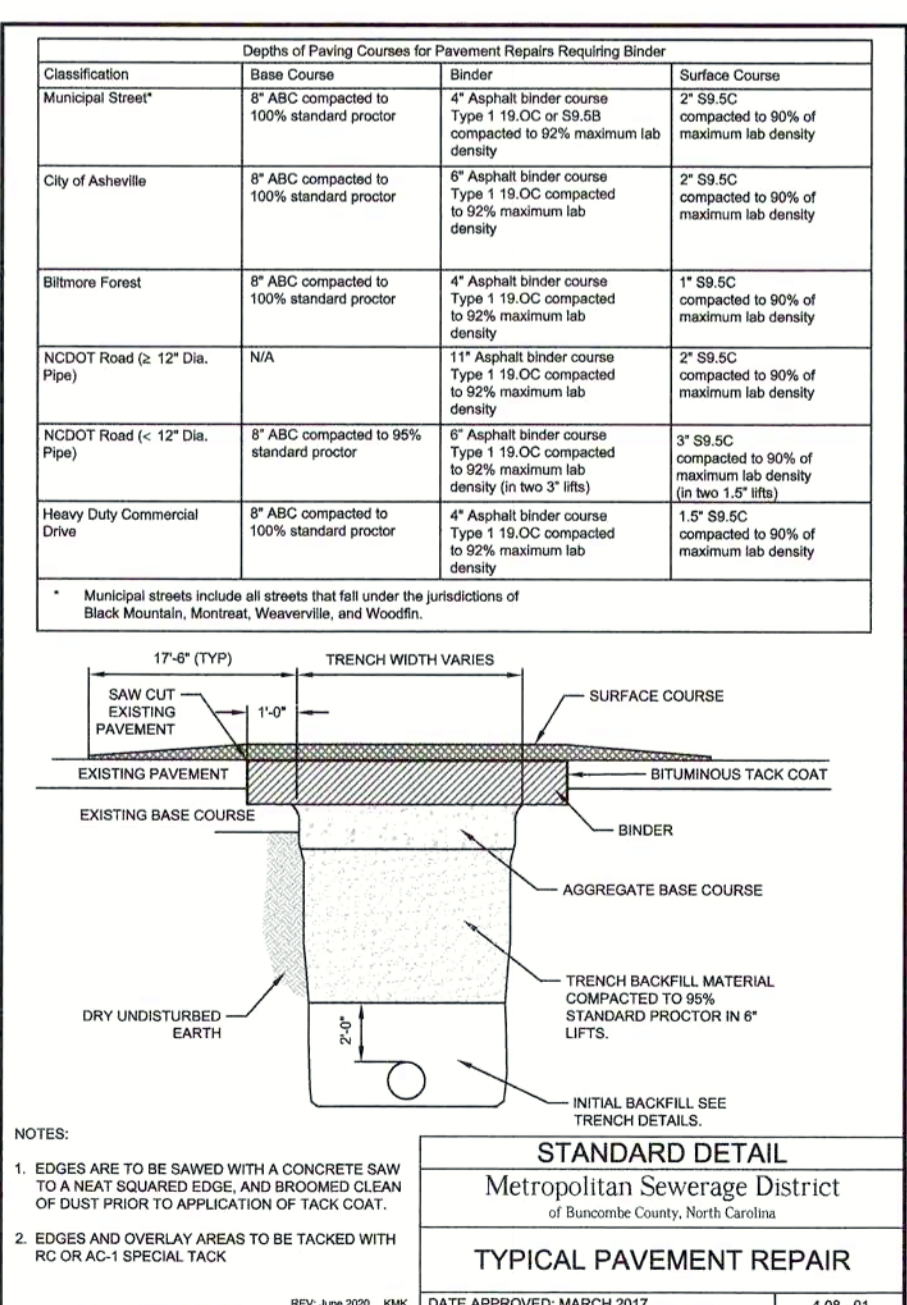
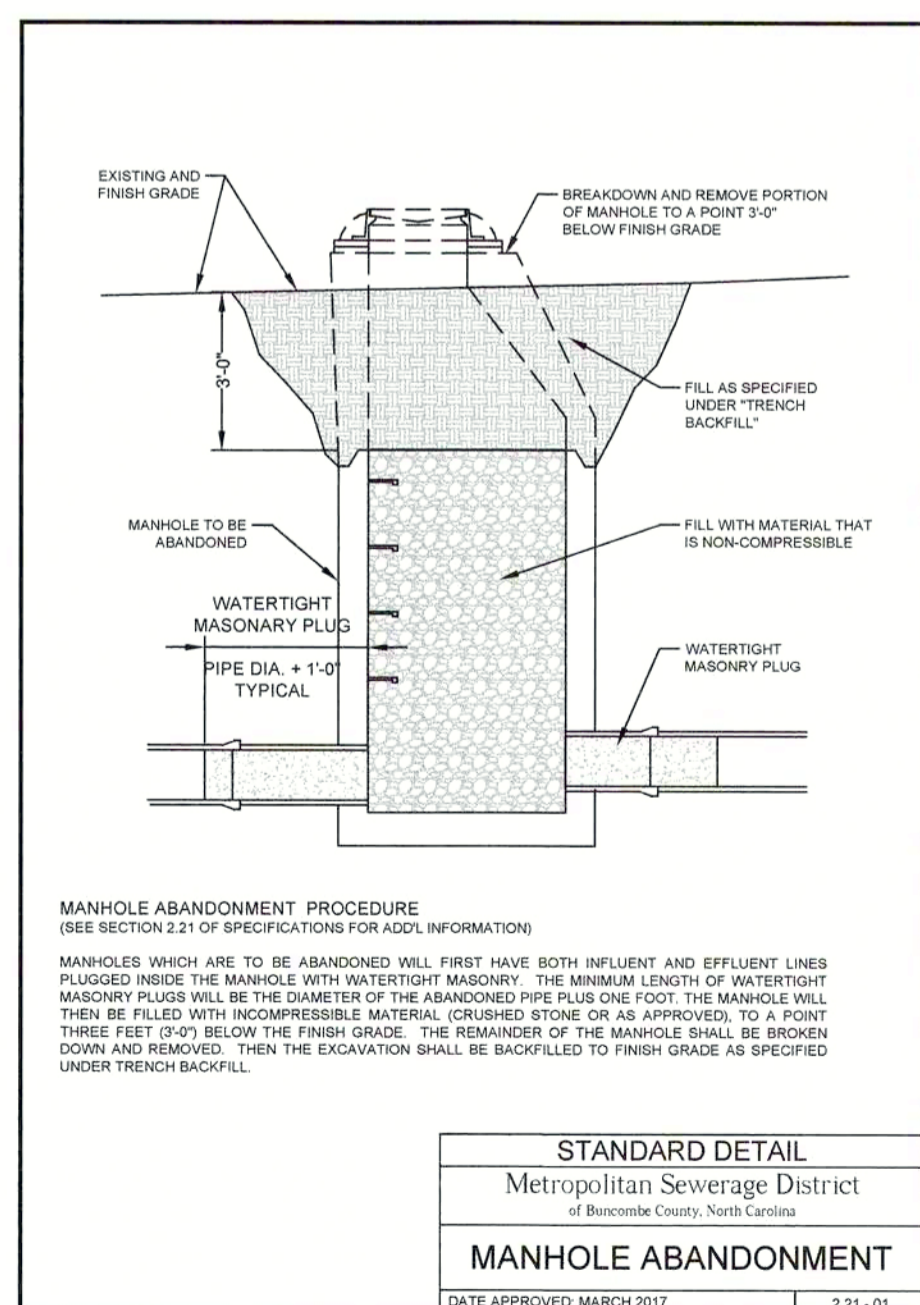
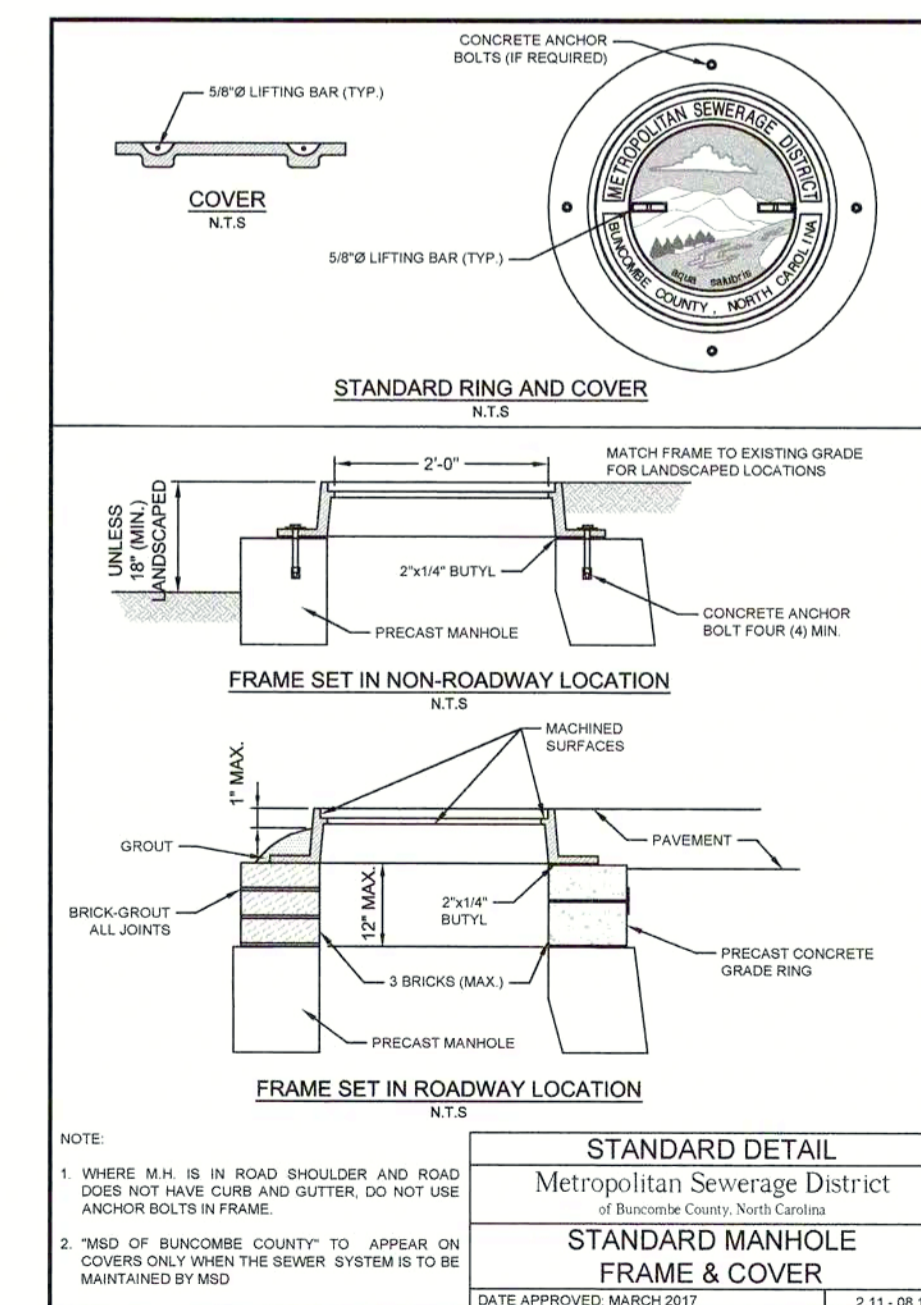
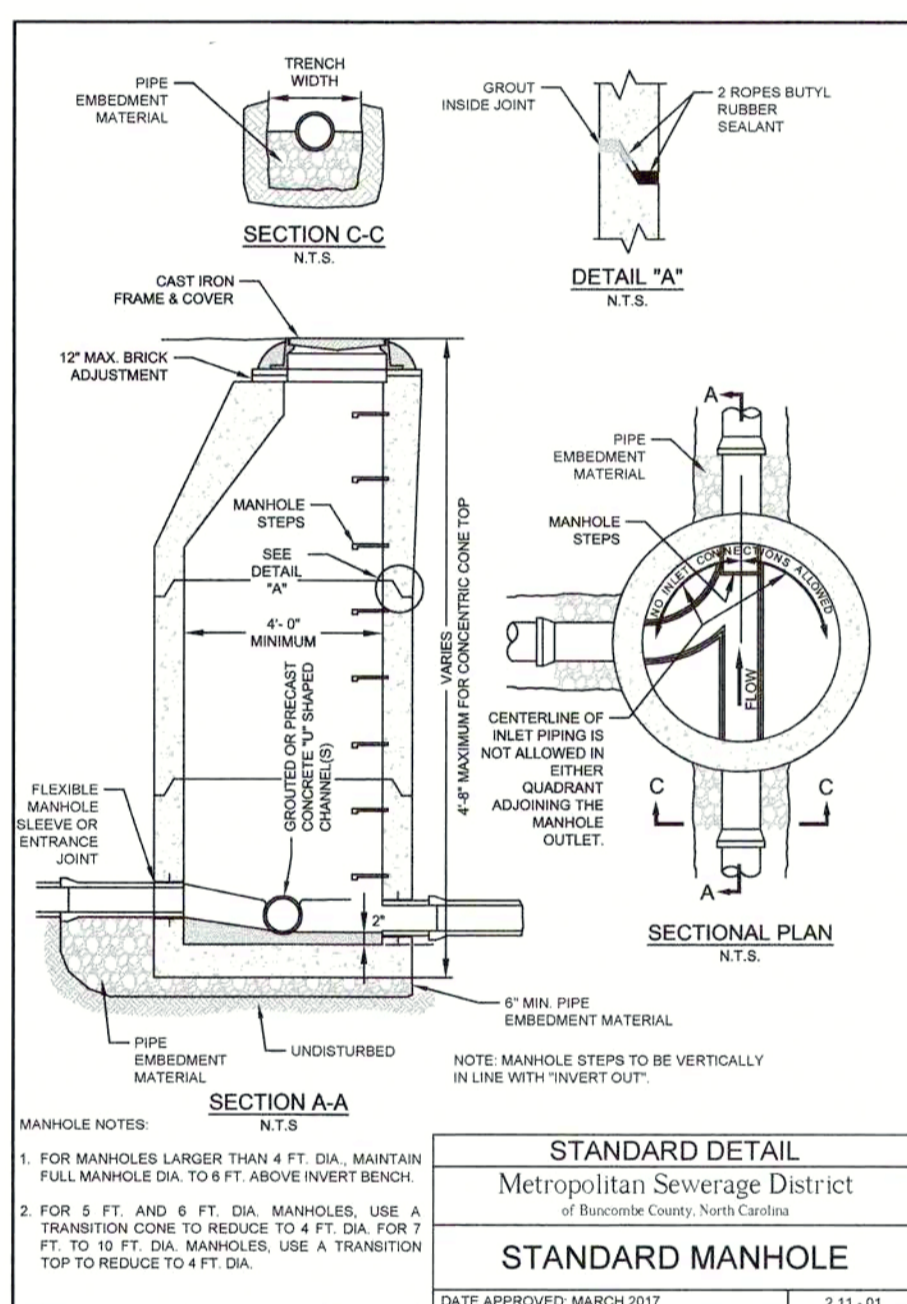
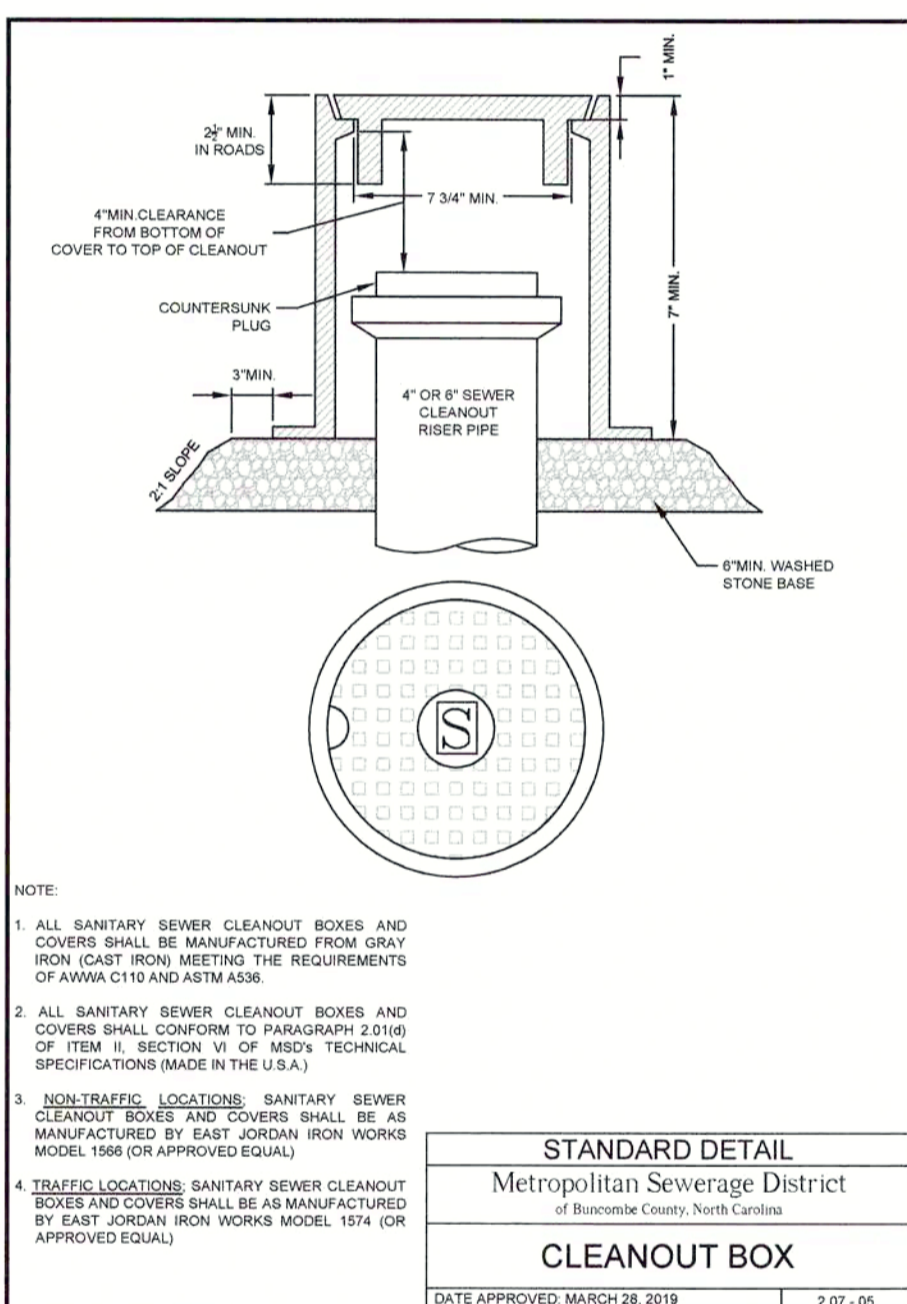
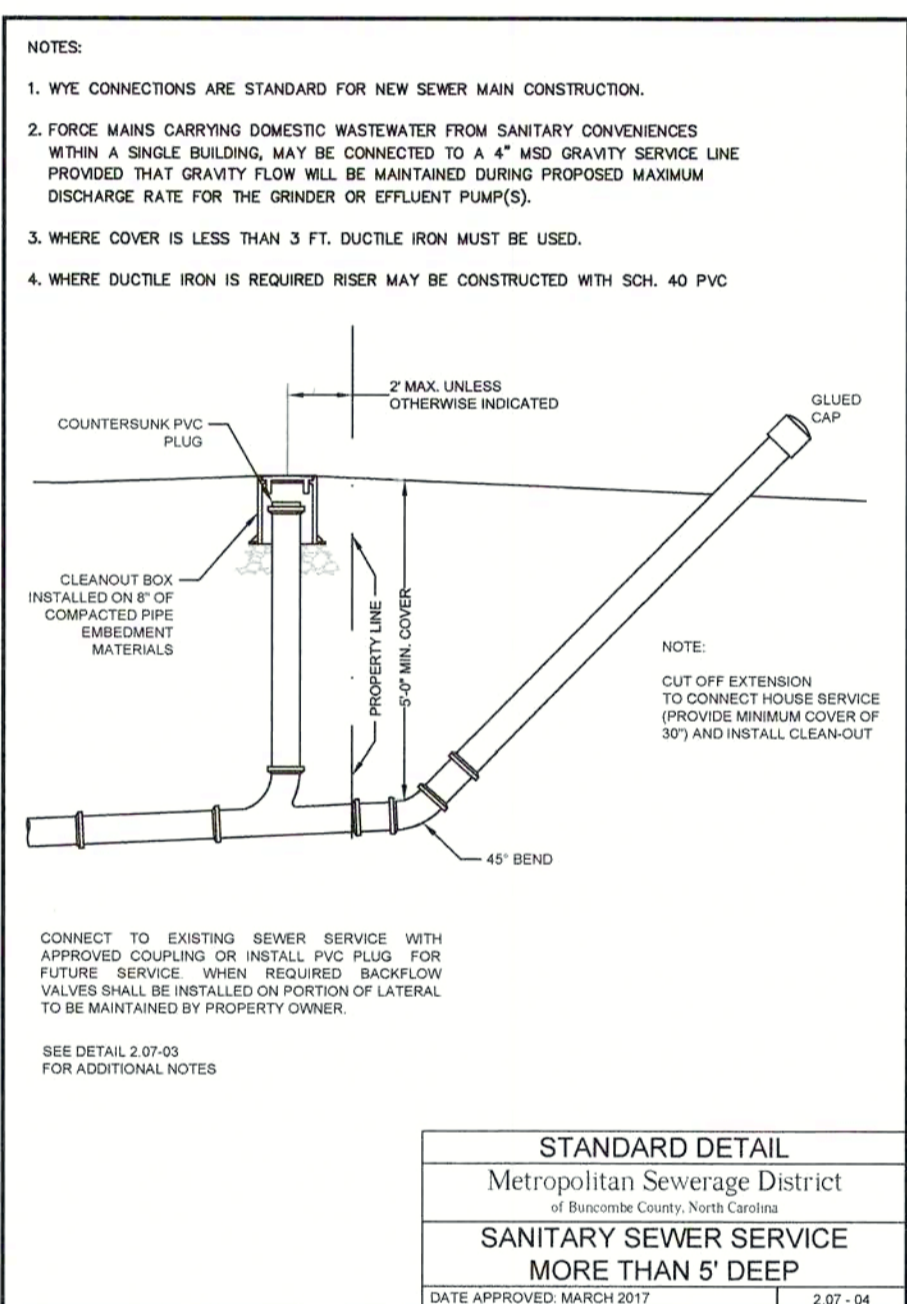
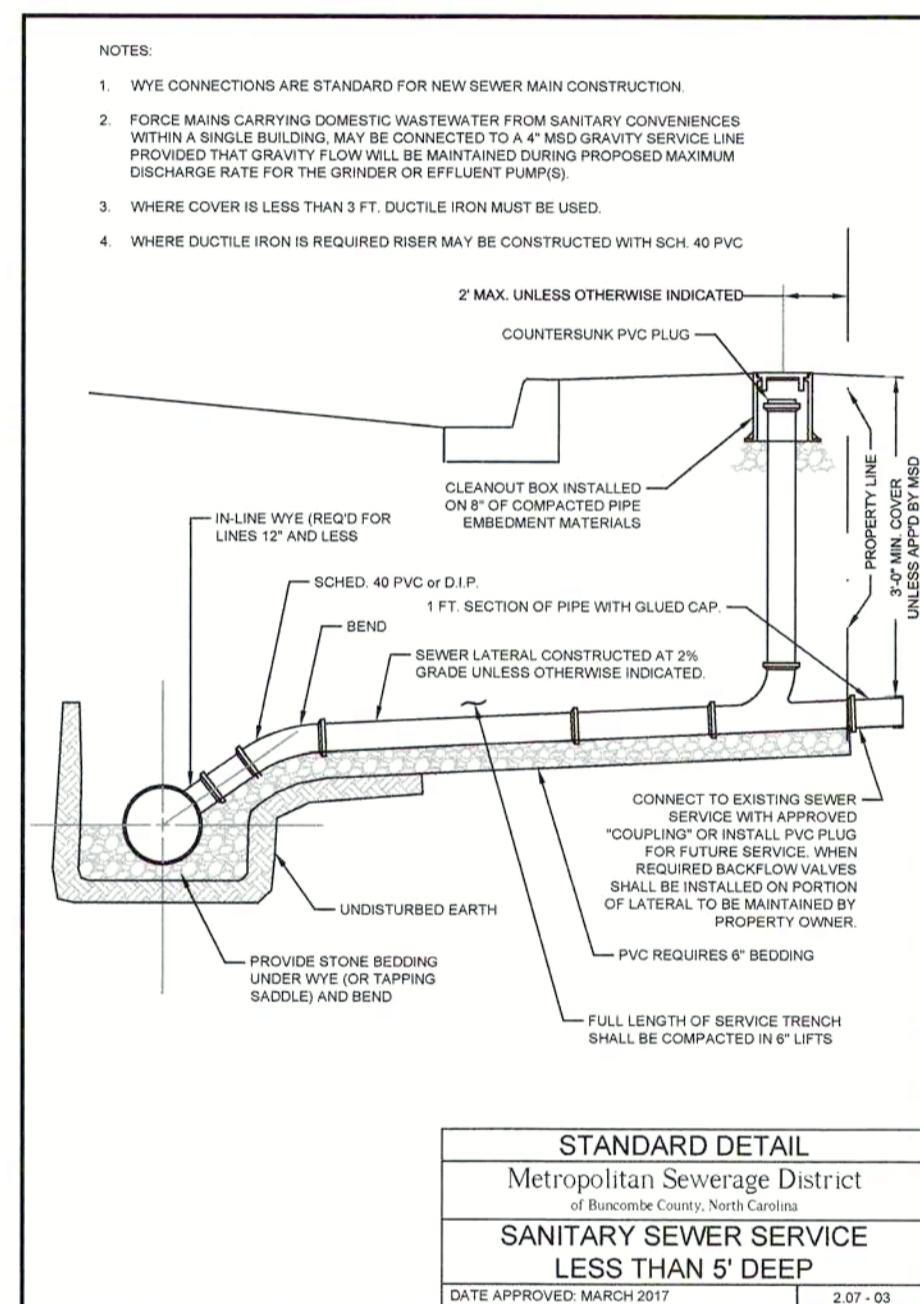
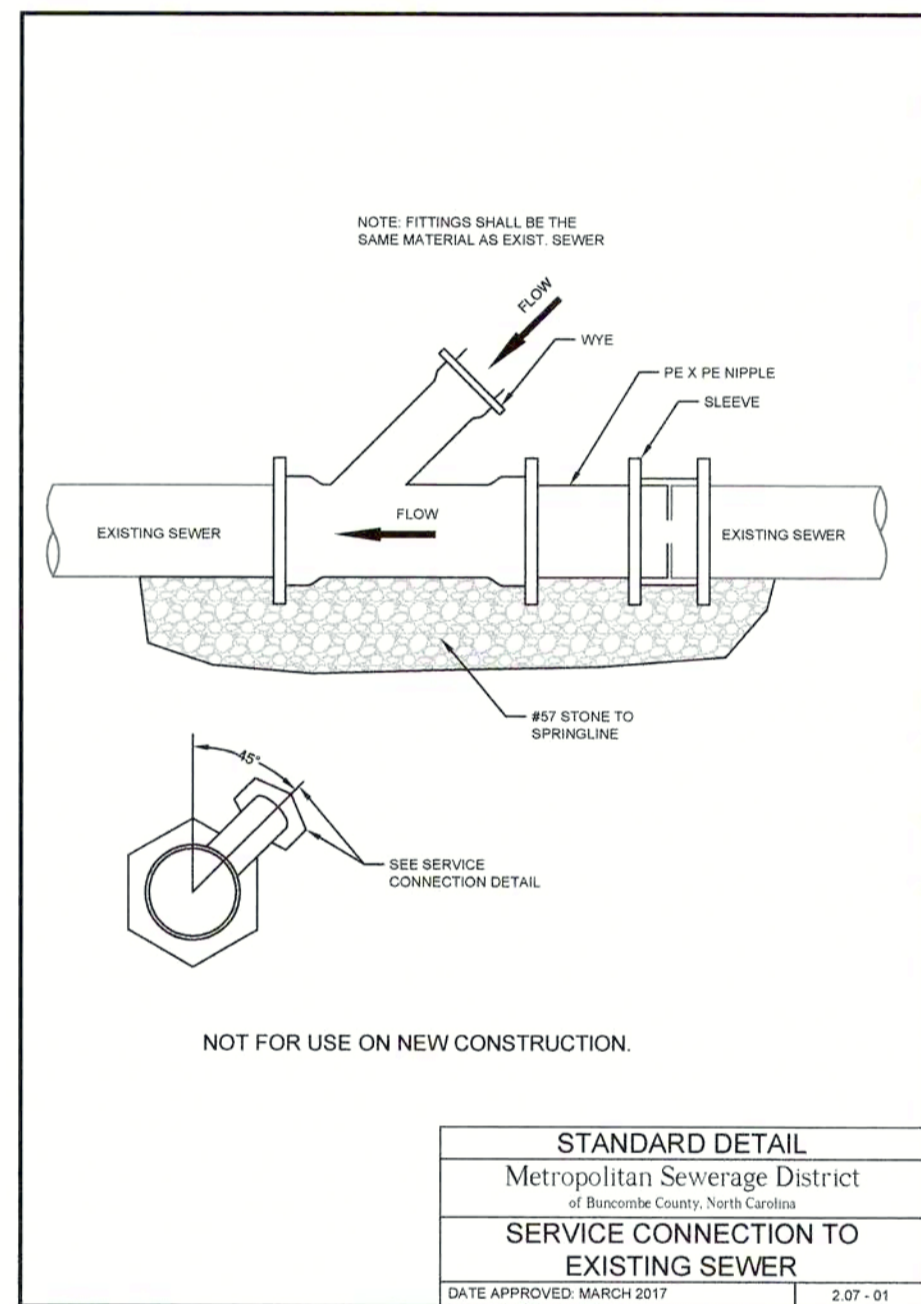

Metropolitan Sewerage District
of Buncombe County

TOXAWAY STREET
Sanitary Sewer Details

DATE: 09/29/2021
SCALE: NTS
DRAWN: JO
CHECKED BY: RMK
APPROVED: SKA

REVISIONS

No. _____ DATE _____ DESCRIPTION _____

MSD

Engineering Division

Metropolitan Sewerage District
of Buncombe County, North Carolina

DATE APPROVED: MARCH 2017 2.11-01.1